



TD-YZJ0812

Ceiling Mounting Bracket

Features

- Aluminum alloy material with surface spray treatment
- Ceiling mounting bracket for dome cameras
- It can be used with the junction box

Specifications

Model	HD-YZJ0812
Material	Aluminum alloy
Color	White
Min. Packaging Quantity	10
Packing Size	500x335x257mm
Dimension	155.3x194.4mm
Net Weight	475g
Load Bearing	The wall must be strong enough to withstand at least 3 times the weight of the camera and the bracket.
Working Temperature	-40°C~+60°C(-40°F~+140°F)
Working Humidity	10% ~ 90%

Available Model

Available Model	HD-YZJ0812	Ceiling mounting bracket
-----------------	------------	--------------------------

Dimensions

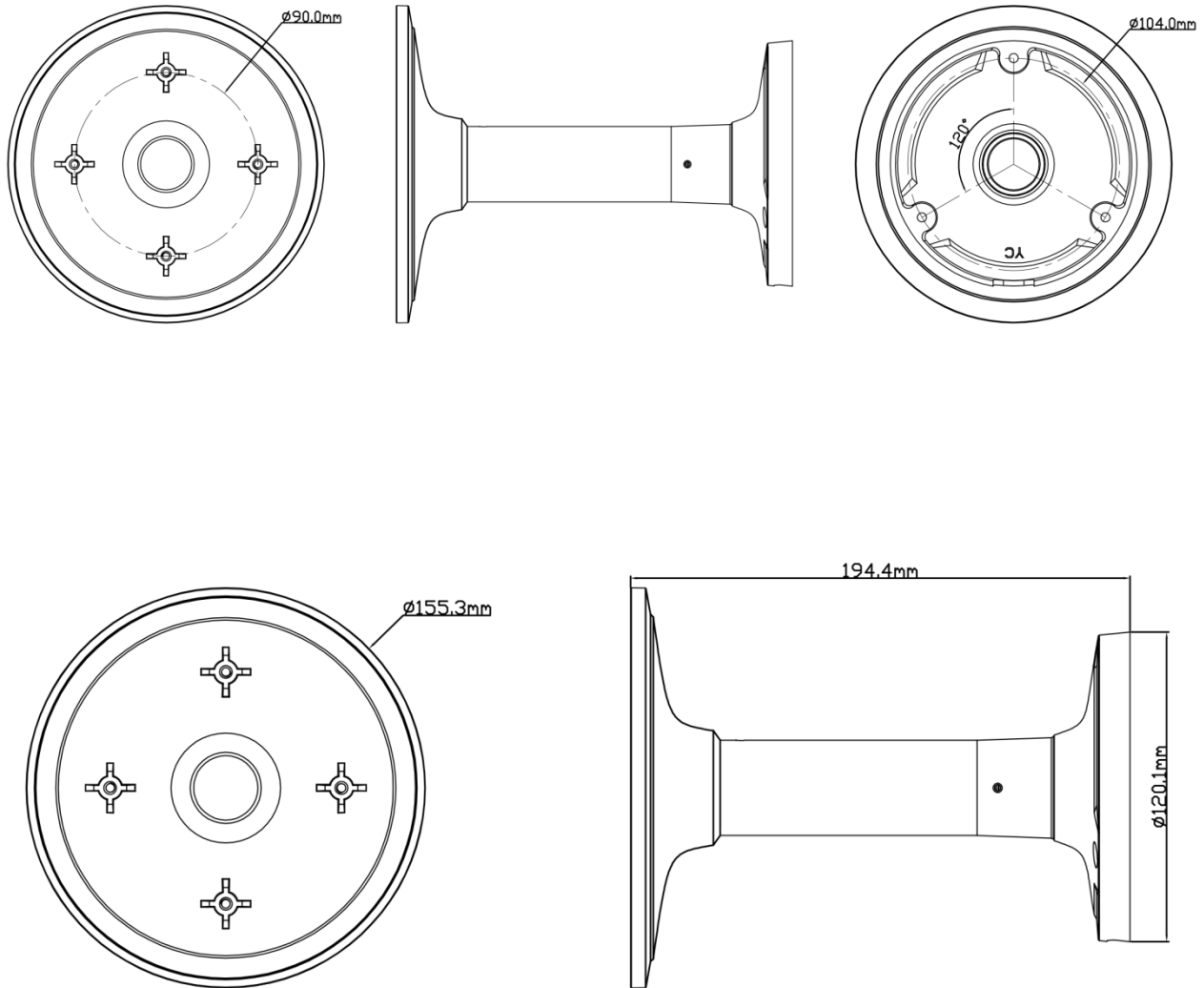

Shenzhen TVT Digital Technology Co., LTD.

Address: 23rd Floor, Block B4, Building NO.9, Shenzhen Bay Eco-Technology Park, Nanshan District, Shenzhen, Guangdong Province, P.R. China

Tel: +86-755-36995888

Website: <http://en.tvt.net.cn>

Fax: +86-755-33104777

E-mail: overseas@tvt.net.cn